

JUMO dTRANS xx 02

In Surface-Mounted Enclosure



B 202551.0.2

Operating Instructions



**WARNING!**

A sudden malfunction of the instrument, or one of the sensors connected to it, could potentially result in dangerous overdosing! Suitable preventive measures must be in place to prevent this from happening.

**NOTE!**



Please read the operating instructions for the basic instrument

- B 202551.0 for JUMO dTRANS pH 02 or
- B 202552.0 for JUMO dTRANS CR 02 or
- B 202553.0 for JUMO dTRANS AS 02 and





these operating instructions before commissioning the instrument. Keep the operating instructions in a place which is accessible to all users at all times.

**NOTE!****To reset the brightness of the LC display:**

If the brightness setting has been adjusted so that the display text is no longer legible, the basic setting can be restored as follows:

- * Switch off the supply voltage.
- * Switch on the supply voltage and immediately press and hold the  and  keys simultaneously.

To set the operator language:

- * Press the  key for longer than 3 seconds.
- * Select the appropriate language with the  and  keys.
- * Briefly press the  key.

**NOTE!**

Optional boards can **only be retrofitted in the factory!**

1	Mounting	5
1.1	Dimensions	5
1.2	Mounting options	5
2	Opening the enclosure	7
2.1	Opening the cover	7
3	Installation of type 202551 (pH)	9
3.1	Installation instructions	9
3.2	Electrical isolation	10
3.3	Connection	11
3.3.1	Terminal assignment	11
3.3.2	PSU board (area I)	11
3.3.3	Main input board (area II)	12
3.3.4	Optional boards (area III, slot a, b or c)	13
4	Installation of type 202552 (CR)	15
4.1	Installation instructions	15
4.2	Electrical isolation	16
4.3	Connection	17
4.3.1	Terminal assignment	17
4.3.2	PSU board (area I)	17
4.3.3	Main input board (area II)	18
4.3.4	Optional boards (area III, slot a, b or c)	19
5	Installation of type 202553 (AS)	21
5.1	Installation instructions	21
5.2	Electrical isolation	22
5.3	Connection	23
5.3.1	Terminal assignment	23
5.3.2	PSU board (area I)	23
5.3.3	Main input board (area II)	24
5.3.4	Optional boards (area III, slot a, b or c)	24
6	Coaxial cable/setup interface	27
6.1	Coaxial cable	27
6.1.1	Coaxial cable with Shield-Kon [®] connector	27
6.1.2	Preparing coaxial cable for your own requirements	27
6.2	Connecting the setup interface	28
6.2.1	Mounting the upper cover	30

Contents

1.1 Dimensions

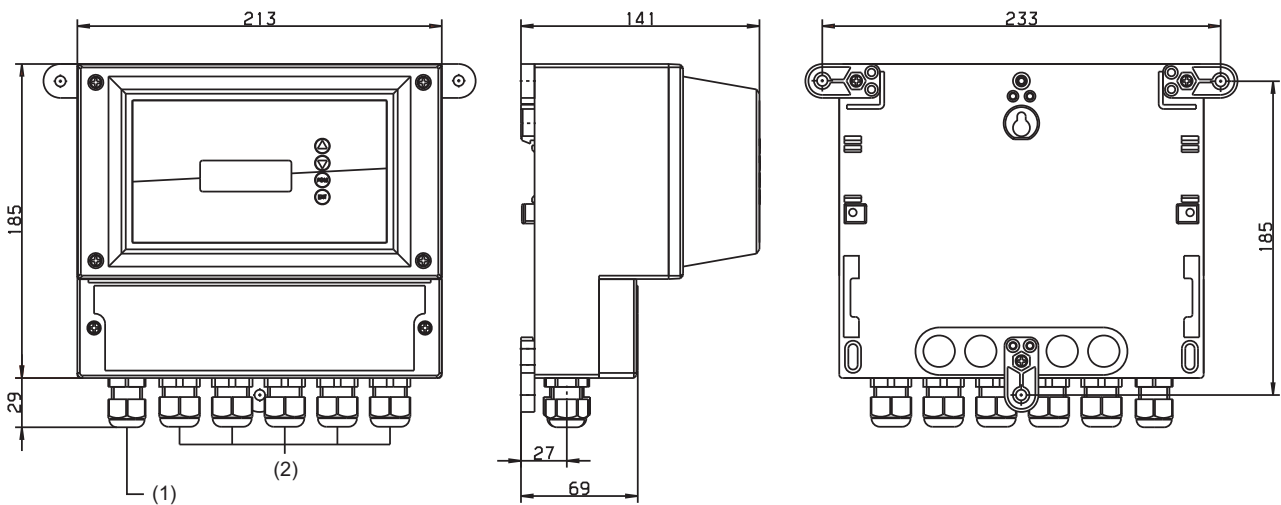

- (1) Cable gland M16
- (2) Cable gland M20

1.2 Mounting options

The enclosure is suitable for screw connection (B) and mounting on a DIN rail (C) per DIN EN 50022 (35 mm × 7.5 mm).

Plastic holders are included with the enclosure for DIN rail mounting.



NOTE!

Use only original parts (B) or (C) for mounting!

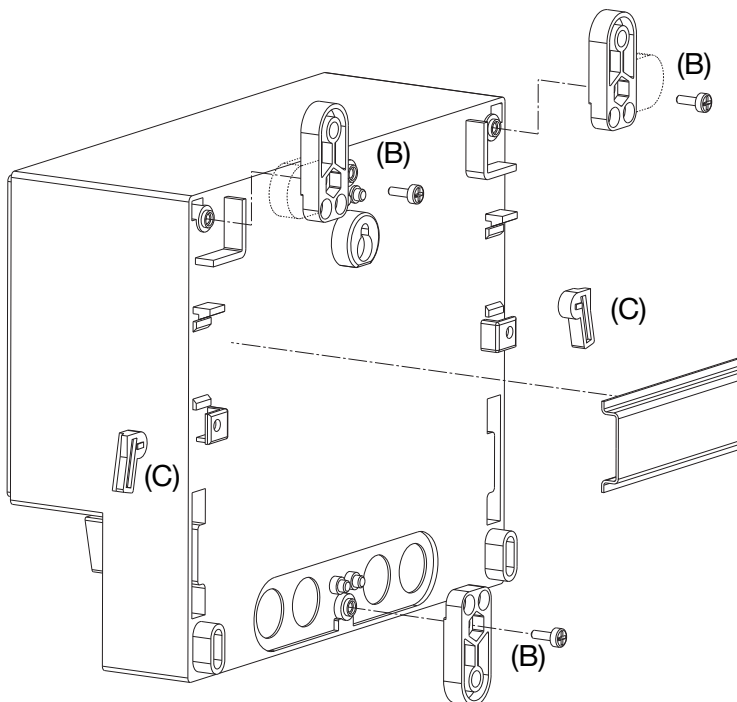

1 Mounting

2 Opening the enclosure

2.1 Opening the cover



CAUTION

Only the lower cover (screws [1]) needs to be screwed on for the electrical connection!

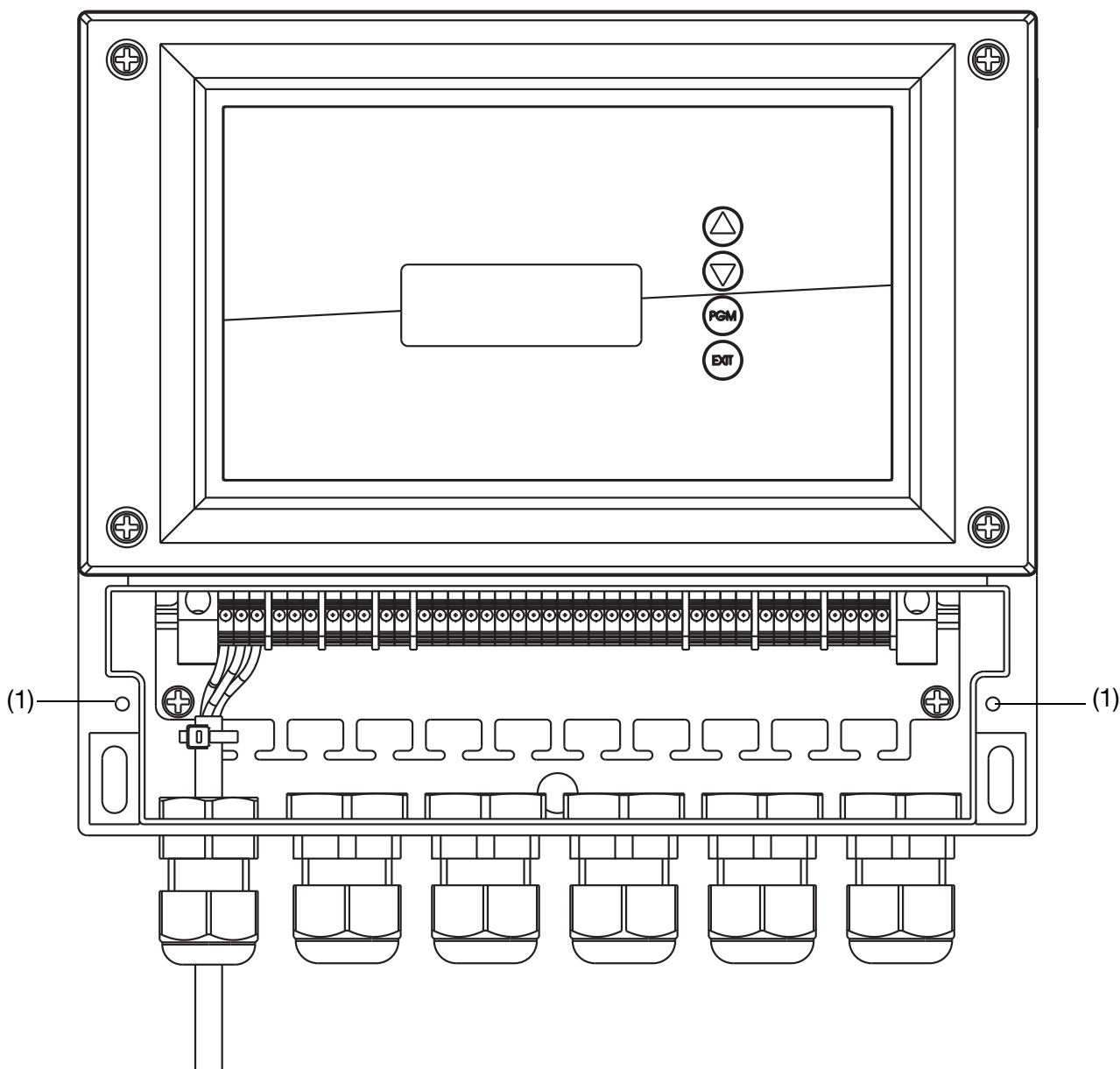

2 Opening the enclosure

3 Installation of type 202551 (pH)

3.1 Installation instructions



DANGER!

The electrical connection must only be performed by qualified personnel!

- The choice of cable, the installation and the electrical connection must conform to the requirements of VDE 0100 “Regulations on the Installation of Power Circuits with Nominal Voltages below 1000 V” and the relevant local regulations
- If contact with live parts is possible when working on the device, it must be completely disconnected from the electrical supply.
- The load circuits must be fused for the maximum load currents in each case to prevent the relay contacts from becoming welded in the event of a short circuit.
- Electromagnetic compatibility meets the requirements of EN 61326.
- Lay the input, output, and supply lines so they are physically separated from each other and are not parallel.
- Use twisted and shielded probe cables. If possible, do not lay these cables close to components or cables through which current is flowing. Ground the shielding at one end.
- The probe cables must have an uninterrupted run (do not route them via terminal blocks or similar arrangements).
- No other consumers can be connected to the power terminals of the instrument.
- The instrument is not suitable for installation in areas with an explosion hazard.
- Apart from faulty installation, incorrect settings on the instrument may also affect the proper functioning of the subsequent process or lead to damage. You should therefore always provide safety equipment that is independent of the instrument and it should only be possible for qualified personnel to make settings.

Mounting information for conductor cross-sections and ferrules

Ferrule		Conductor cross-section		Length of ferrule or stripping
		Minimum	Maximum	
Without ferrule	Single-core	0.5 mm ²	1.5 mm ²	7 mm
	Multi-core	1.5 mm ²	1.5 mm ²	7 mm
	Finely stranded	-	1.5 mm ²	7 mm
Without collar to DIN 46228/1	Finely stranded	0.5 mm ²	1.5 mm ²	6 mm
With collar, up to 1.5mm ² to DIN 46228/4	Finely stranded	0.5 mm ²	0.5 mm ²	6 mm

3 Installation of type 202551 (pH)

3.2 Electrical isolation

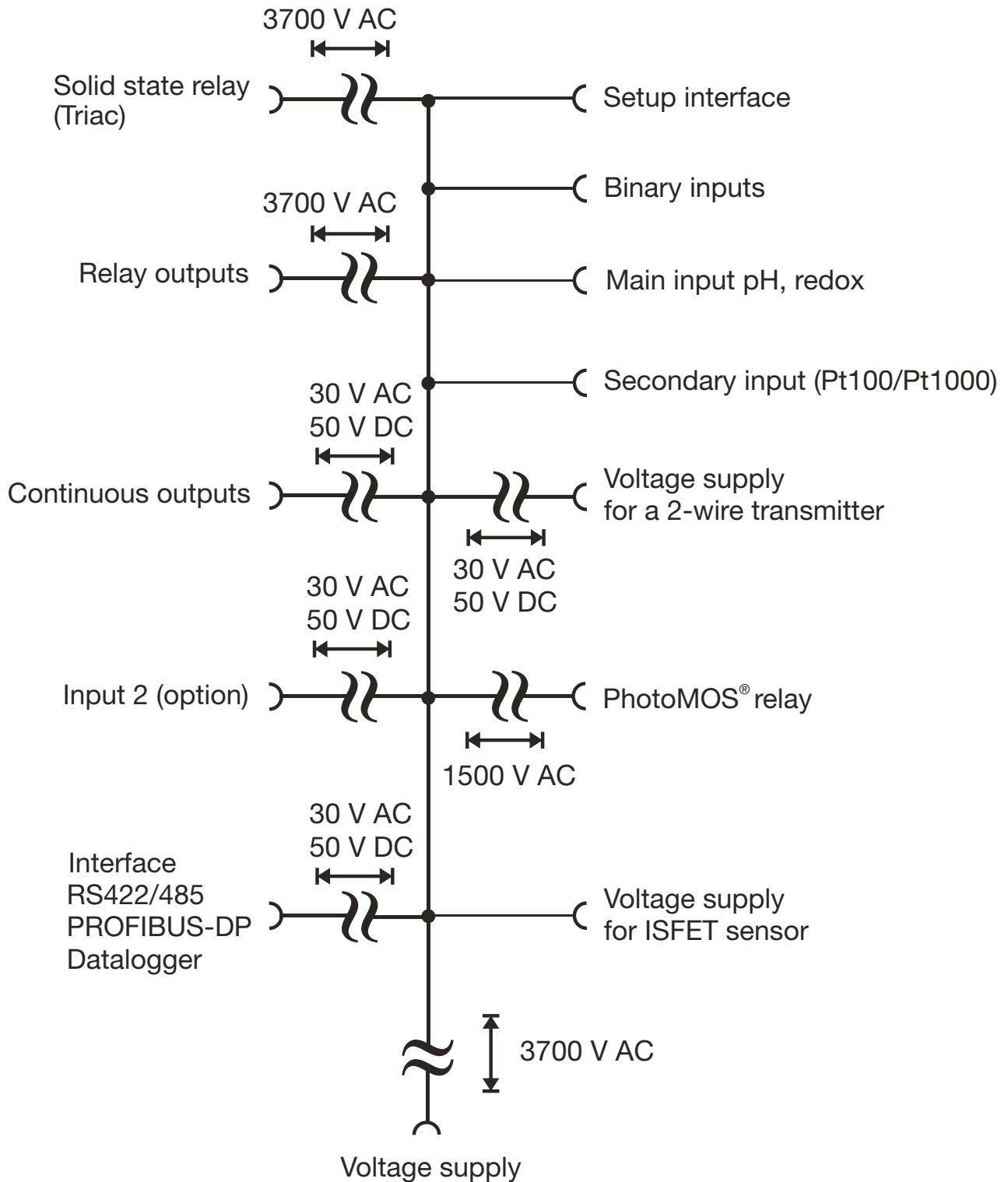

3 Installation of type 202551 (pH)

3.3 Connection

* Unscrew the lower cover, see section 2.1 "Opening the cover", page 7.

3.3.1 Terminal assignment

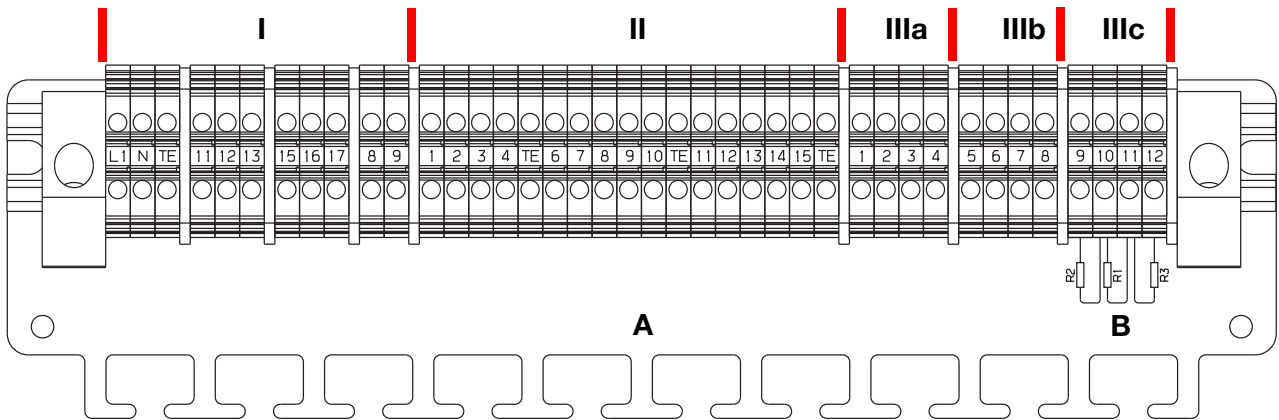

(I)	PSU board	Voltage supply/2× relays
(II)	Main input board	pH/redox/temperature/standard signal
(IIIa)	Optional board	Optional slot 1
(IIIb)	Optional board	Optional slot 2
(IIIc)	Optional board	Optional slot 3
A	Retaining plate for fastening connecting cables with cable ties	
B	Terminal resistors for PROFIBUS-DP (only present if optional board is fitted - remove if necessary)	

3.3.2 PSU board (area I)

Function	Symbol	Terminal
Voltage supply		
Voltage supply AC 110 to 240 V	—○	1 L1 (L+)
Voltage supply AC/DC 20 to 30 V	—○	2 N (L-)
Technical ground		TG
Voltage supply for external 2-wire transmitter		
DC 24 V (+20/-15 %)	—○	8 L +
	—○	9 L -
Relay 1		
Switching output K1 (floating)		11 12 13
Relay 2		

3 Installation of type 202551 (pH)

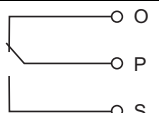
Function	Symbol	Terminal
Switching output K2 (floating)		15 16 17

3.3.3 Main input board (area II)

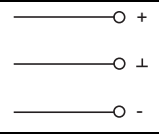
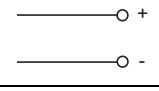
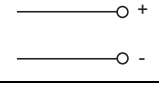
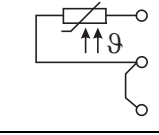
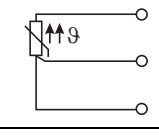
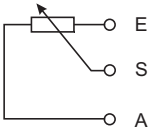
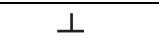
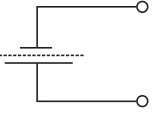
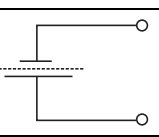
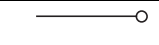
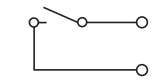
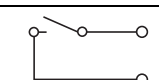
Function	Symbol	Terminal
Voltage supply for ISFET sensor DC ± 4.85 V GND		11 10 15
Standard signal input for electrical current 0(4) to 20 mA		3 4
Standard signal input for voltage 0(2) to 10 V or 10 to 0(2) V		1 4
Temperature sensor in a two-wire circuit Pt100 or Pt1000		2 3 4
Temperature sensor in a three-wire circuit Pt100 or Pt1000		2 3 4
Resistance transmitter		4 3 2
pH/redox electrode		
Shield for pH (with triaxial cable only!)		6
Glass/metal electrode		7
Reference electrode		8
Liquid potential (LP) With asymmetrical connection, bridge between terminal 8 and 9 With symmetrical connection, LP on terminal 9		9
Binary inputs		
Binary input 1		12+ 14
Binary input 2		13+ 14

3 Installation of type 202551 (pH)

3.3.4 Optional boards (area III, slot a, b or c)

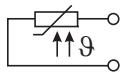
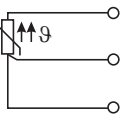
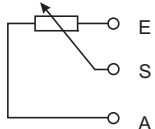
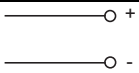
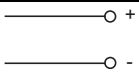
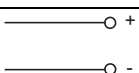
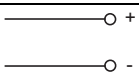
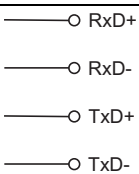
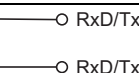
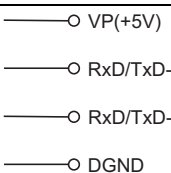
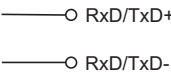
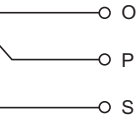
Function	Symbol	Terminal for slot (a)	Terminal for slot (b)	Terminal for slot (c)
Analog input				
Temperature sensor in a two-wire circuit Pt100 or Pt1000		2	6	10
		4	8	12
Temperature sensor in a three-wire circuit Pt100 or Pt1000		2	6	10
		3	7	11
		4	8	12
Resistance transmitter		2	6	10
		3	7	11
		4	8	12
Electrical current		3	7	11
		4	8	12
Voltage 0(2) to 10 V		1	5	9
		2	6	10
Voltage 0 to 1 V		2	6	10
		3	7	11
Continuous output				
Current or voltage		2	6	10
		3	7	11
Modbus interface				
RS422				9
				10
				11
				12
RS485				11
				12
PROFIBUS-DP interface				
				9
				10
				11
				12
Datalogger interface				
RS485				10
				11
Relay (1x changeover)				
		K3 1	K4 5	K5 9
		2	6	10
		3	7	11

3 Installation of type 202551 (pH)

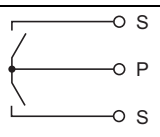
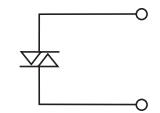
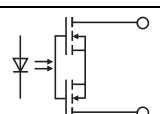
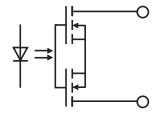
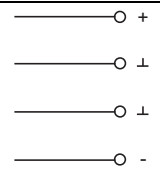
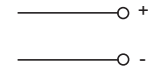
Function	Symbol	Terminal for slot (a)	Terminal for slot (b)	Terminal for slot (c)
Relay (2× NO, common pin)				
		K3 1 2 K6 3		K5 9 10 K8 11
Triac (1 A)				
		K3 2 3	K4 6 7	K5 10 11
PhotoMOS[®] relay (0.2 A)				
		K3 1 2	K4 5 6	K5 9 10
		K6 3 4	K7 7 8	K8 11 12
Voltage supply for ISFET sensor				
DC ±5 V GND		1 2 3 4	5 6 7 8	9 10 11 12
DC +12 V GND		1 2	5 6	9 10

4 Installation of type 202552 (CR)

4.1 Installation instructions



DANGER!

The electrical connection must only be performed by qualified personnel!

- The choice of cable, the installation and the electrical connection must conform to the requirements of VDE 0100 “Regulations on the Installation of Power Circuits with Nominal Voltages below 1000 V” and the relevant local regulations
- If contact with live parts is possible when working on the device, it must be completely disconnected from the electrical supply.
- The load circuits must be fused for the maximum load currents in each case to prevent the relay contacts from becoming welded in the event of a short circuit.
- Electromagnetic compatibility meets the requirements of EN 61326.
- Lay the input, output, and supply lines so they are physically separated from each other and are not parallel.
- Use twisted and shielded probe cables. If possible, do not lay these cables close to components or cables through which current is flowing. Ground the shielding at one end.
- The probe cables must have an uninterrupted run (do not route them via terminal blocks or similar arrangements).
- No other consumers can be connected to the power terminals of the instrument.
- The instrument is not suitable for installation in areas with an explosion hazard.
- Apart from faulty installation, incorrect settings on the instrument may also affect the proper functioning of the subsequent process or lead to damage. You should therefore always provide safety equipment that is independent of the instrument and it should only be possible for qualified personnel to make settings.

Mounting information for conductor cross-sections and ferrules

Ferrule		Conductor cross-section		Length of ferrule or stripping
		Minimum	Maximum	
Without ferrule	Single-core	0.5 mm ²	1.5 mm ²	7 mm
	Multi-core	1.5 mm ²	1.5 mm ²	7 mm
	Finely stranded	-	1.5 mm ²	7 mm
Without collar to DIN 46228/1	Finely stranded	0.5 mm ²	1.5 mm ²	6 mm
With collar, up to 1.5mm ² to DIN 46228/4	Finely stranded	0.5 mm ²	0.5 mm ²	6 mm

4 Installation of type 202552 (CR)

4.2 Electrical isolation

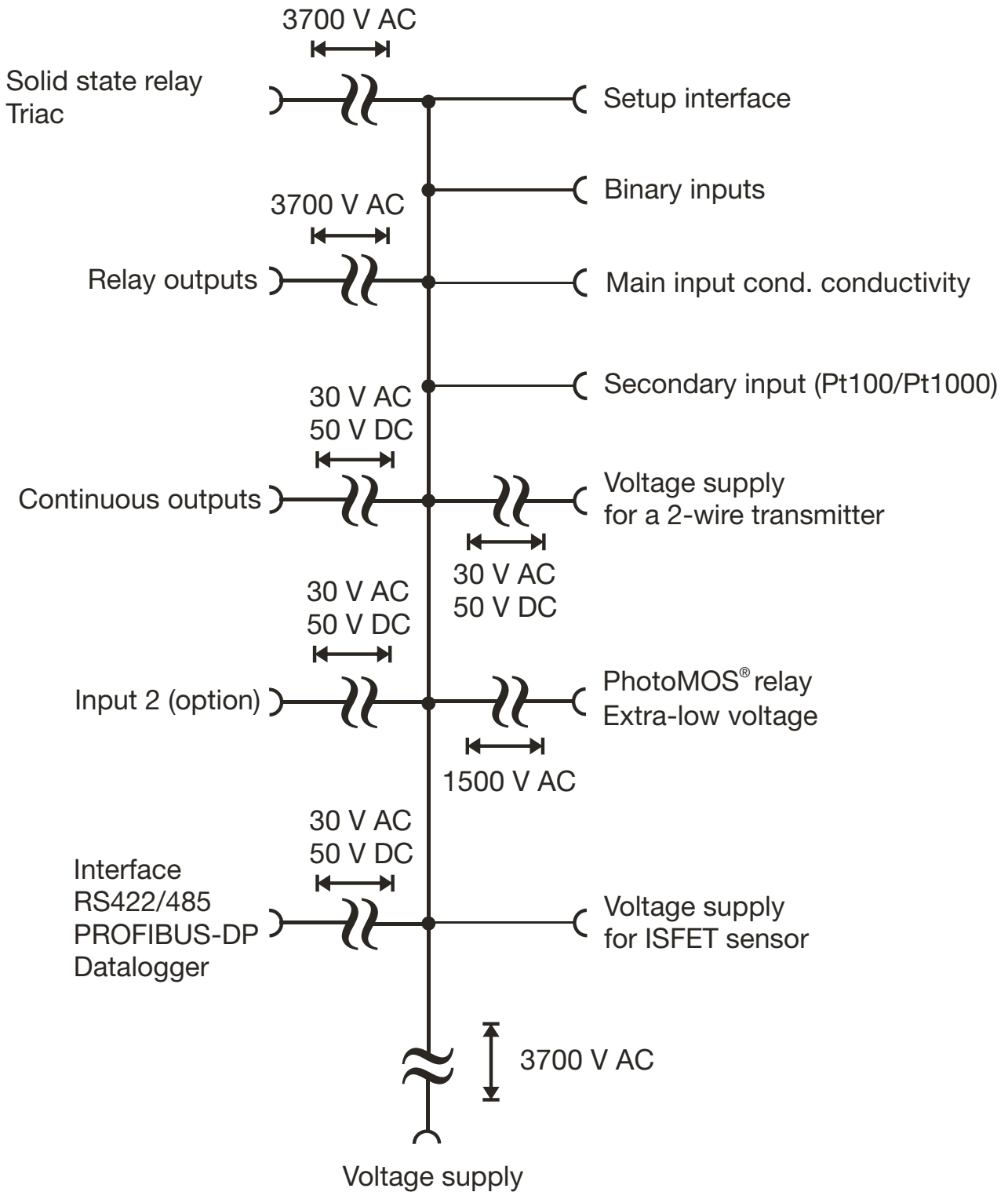

4 Installation of type 202552 (CR)

4.3 Connection

* Unscrew the lower cover, see section 2.1 "Opening the cover", page 7.

4.3.1 Terminal assignment

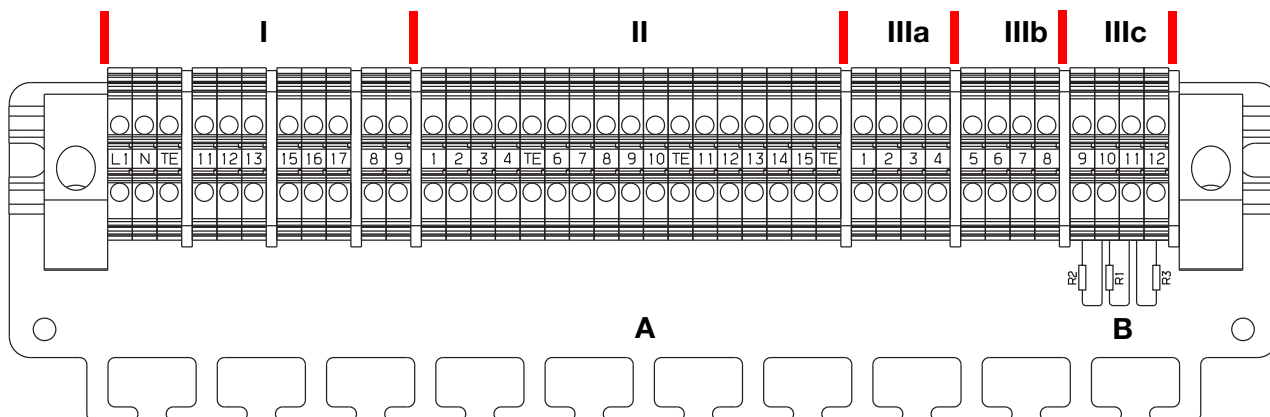

(I)	PSU board	Voltage supply/2× relays
(II)	Main input board	pH/redox/temperature/standard signal
(IIIa)	Optional board	Optional slot 1
(IIIb)	Optional board	Optional slot 2
(IIIc)	Optional board	Optional slot 3
A	Retaining plate for fastening connecting cables with cable ties	
B	Terminal resistors for PROFIBUS-DP (only present if optional board is fitted - remove if necessary)	

4.3.2 PSU board (area I)

Function	Symbol	Terminal
Voltage supply		
Voltage supply AC 110 to 240 V	—○	1 L1 (L+)
Voltage supply AC/DC 20 to 30 V	—○	2 N (L-)
Technical ground	⏏	TG
Voltage supply for external 2-wire transmitter		
DC 24 V (+20/-15 %)	—○	8 L +
	—○	9 L -
Relay 1		

4 Installation of type 202552 (CR)

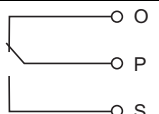
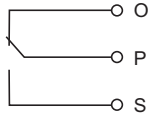
Function	Symbol	Terminal
Switching output K1 (floating)		11 12 13
Relay 2		
Switching output K2 (floating)		15 16 17



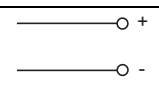
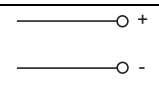
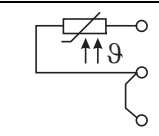
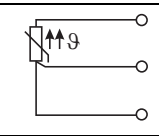
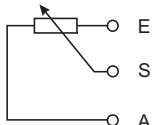
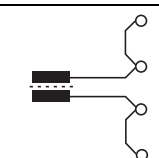
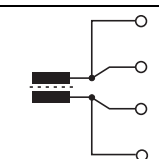
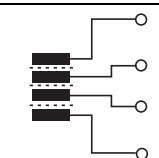

4.3.3 Main input board (area II)

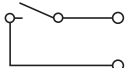
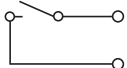
Function	Symbol	Terminal
Standard signal input for electrical current 0(4) to 20 mA		3 4
Standard signal input for voltage 0(2) to 10 V or 10 to 0(2) V		1 4
Temperature sensor in a two-wire circuit Pt100 or Pt1000		2 3 4
Temperature sensor in a three-wire circuit Pt100 or Pt1000		2 3 4
Resistance transmitter		4 3 2
Conductivity sensor		
Conductivity sensor (2-electrode system) Terminals 6+7 and 8+9 can be bridged on the instrument; 2-wire cable routing up to the head of the conductivity sensor. For concentric cells, terminal 6 must be connected with the outer electrode.		6 7 8 9
Conductivity sensor (2-electrode system) Wiring for highest accuracy; 4-wire cable routing to the head of the conductivity sensor. For concentric cells, terminal 6 must be connected with the outer electrode.		6 7 8 9
Conductivity sensor (4-electrode system) 6 - Outer electrode 1 7 - Inner electrode 1 8 - Inner electrode 2 9 - Outer electrode 2		6 7 8 9
Shield connection		

4 Installation of type 202552 (CR)

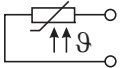
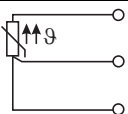
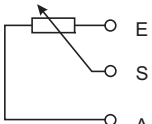
Function	Symbol	Terminal
Conductivity sensor		10 GND
Binary inputs		
Binary input 1		12+ 14
Binary input 2		13+ 14

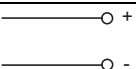
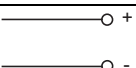
4.3.4 Optional boards (area III, slot a, b or c)

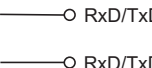
Function	Symbol	Terminal for slot (a)	Terminal for slot (b)	Terminal for slot (c)
Analog input				
Temperature sensor in a two-wire circuit Pt100 or Pt1000		2	6	10
		4	8	12
Temperature sensor in a three-wire circuit Pt100 or Pt1000		2	6	10
		3	7	11
		4	8	12
Resistance transmitter		2	6	10
		3	7	11
		4	8	12
Electrical current		3	7	11
		4	8	12
Voltage 0(2) to 10 V		1	5	9
		2	6	10
Voltage 0 to 1 V		2	6	10
		3	7	11
Continuous output				
Current or voltage		2	6	10
		3	7	11
Modbus interface				
RS422				9
				10
				11
				12
RS485				11
				12
PROFIBUS-DP interface				

4 Installation of type 202552 (CR)

				9 10 11 12
Function	Symbol	Terminal for slot (a)	Terminal for slot (b)	Terminal for slot (c)
Datalogger interface				
RS485				10 11
Relay (1x changeover)				
		K3 1 2 3	K4 5 6 7	K5 9 10 11
Relay (2x NO, common pin)				
		K3 1 2 K6 3		K5 9 10 K8 11
Triac (1 A)				
		K3 2 3	K4 6 7	K5 10 11
PhotoMOS[®] relay (0.2 A)				
		K3 1 2	K4 5 6	K5 9 10
		K6 3 4	K7 7 8	K8 11 12
Voltage supply for ISFET sensor				
DC ±5 V GND		1 2 3 4	5 6 7 8	9 10 11 12
DC +12 V GND		1 2	5 6	9 10

5 Installation of type 202553 (AS)

5.1 Installation instructions



DANGER!

The electrical connection must only be performed by qualified personnel!

- The choice of cable, the installation and the electrical connection must conform to the requirements of VDE 0100 “Regulations on the Installation of Power Circuits with Nominal Voltages below 1000 V” and the relevant local regulations
- If contact with live parts is possible when working on the device, it must be completely disconnected from the electrical supply.
- The load circuits must be fused for the maximum load currents in each case to prevent the relay contacts from becoming welded in the event of a short circuit.
- Electromagnetic compatibility meets the requirements of EN 61326.
- Lay the input, output, and supply lines so they are physically separated from each other and are not parallel.
- Use twisted and shielded probe cables. If possible, do not lay these cables close to components or cables through which current is flowing. Ground the shielding at one end.
- The probe cables must have an uninterrupted run (do not route them via terminal blocks or similar arrangements).
- No other consumers can be connected to the power terminals of the instrument.
- The instrument is not suitable for installation in areas with an explosion hazard.
- Apart from faulty installation, incorrect settings on the instrument may also affect the proper functioning of the subsequent process or lead to damage. You should therefore always provide safety equipment that is independent of the instrument and it should only be possible for qualified personnel to make settings.

Mounting information for conductor cross-sections and ferrules

Ferrule		Conductor cross-section		Length of ferrule or stripping
		Minimum	Maximum	
Without ferrule	Single-core	0.5 mm ²	1.5 mm ²	7 mm
	Multi-core	1.5 mm ²	1.5 mm ²	7 mm
	Finely stranded	-	1.5 mm ²	7 mm
Without collar to DIN 46228/1	Finely stranded	0.5 mm ²	1.5 mm ²	6 mm
With collar, up to 1.5mm ² to DIN 46228/4	Finely stranded	0.5 mm ²	0.5 mm ²	6 mm

5 Installation of type 202553 (AS)

5.2 Electrical isolation

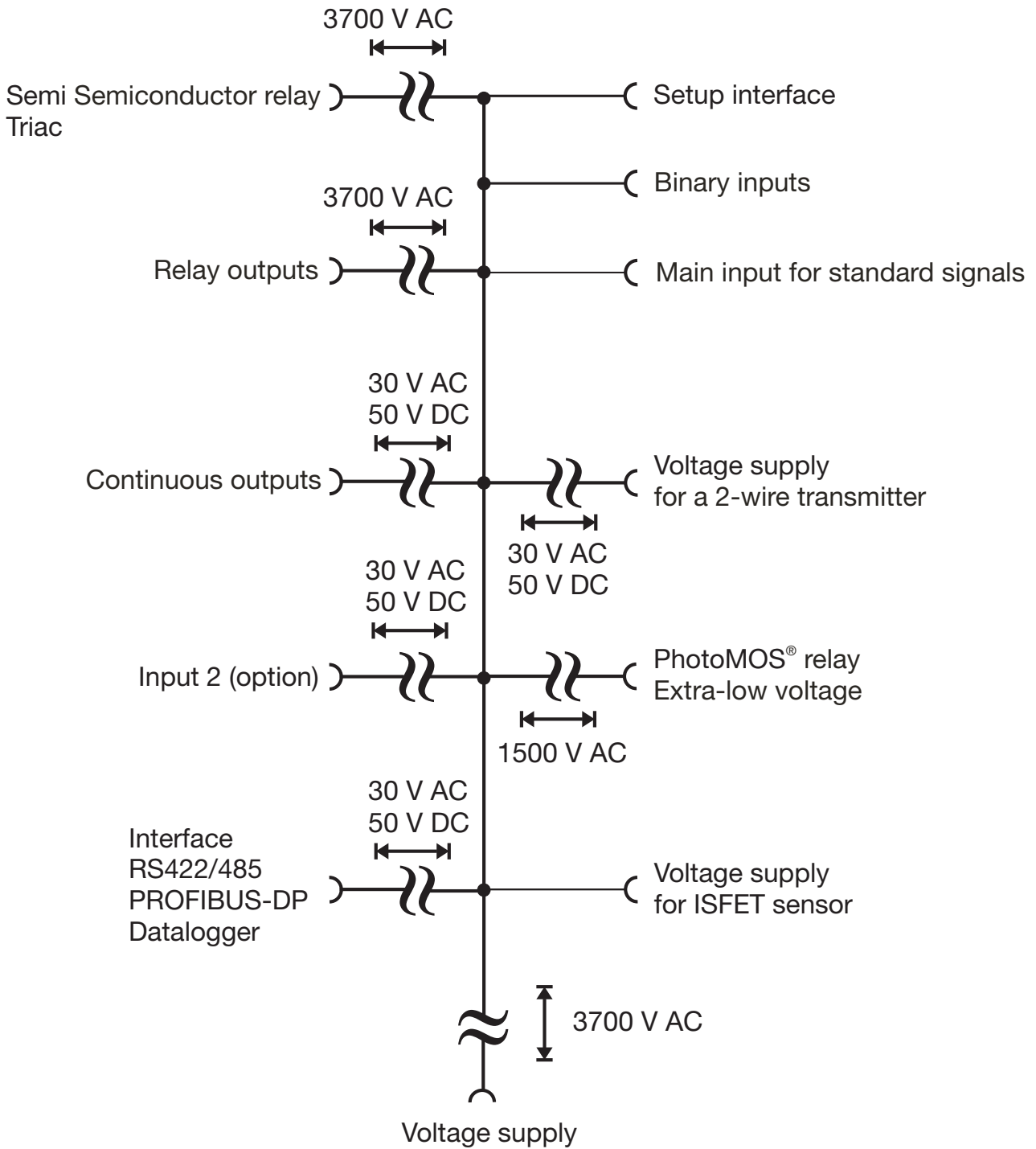

5 Installation of type 202553 (AS)

5.3 Connection

* Unscrew the lower cover, see section 2.1 "Opening the cover", page 7.

5.3.1 Terminal assignment

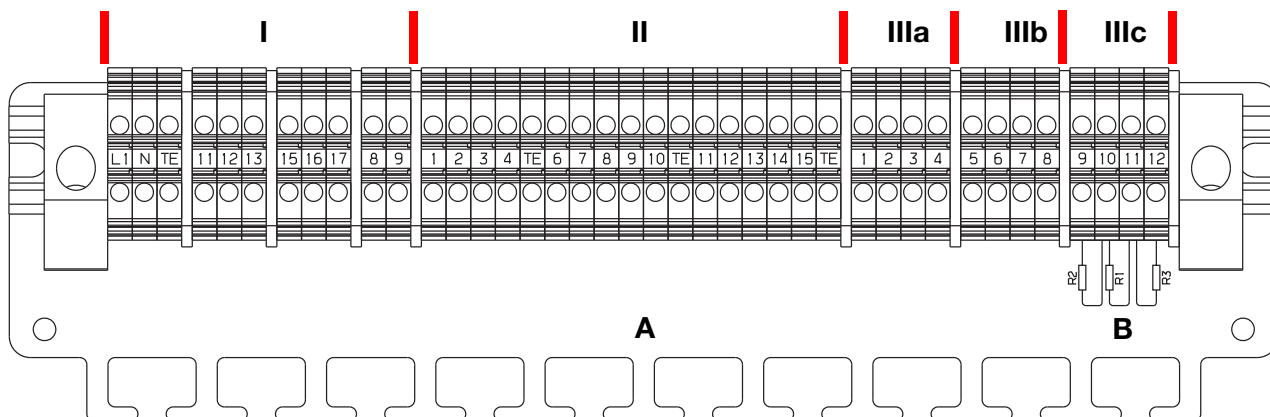

(I)	PSU board	Voltage supply/2x relays
(II)	Main input board	pH/redox/temperature/standard signal
(IIIa)	Optional board	Optional slot 1
(IIIb)	Optional board	Optional slot 2
(IIIc)	Optional board	Optional slot 3
A	Retaining plate for fastening connecting cables with cable ties	
B	Terminal resistors for PROFIBUS-DP (only present if optional board is fitted - remove if necessary)	

5.3.2 PSU board (area I)

Function	Symbol	Terminal
Voltage supply		
Voltage supply AC 110 to 240 V	—○	1 L1 (L+)
Voltage supply AC/DC 20 to 30 V	—○	2 N (L-)
Technical ground	⏏	TG
Voltage supply for external 2-wire transmitter		
DC 24 V (+20/-15 %)	—○	8 L +
	—○	9 L -
Relay 1		
Switching output K1 (floating)		11 12 13
Relay 2		

5 Installation of type 202553 (AS)

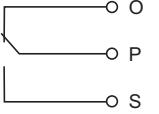
Function	Symbol	Terminal
Switching output K2 (floating)		15 16 17

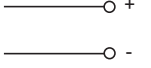
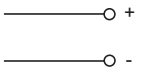
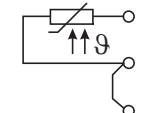
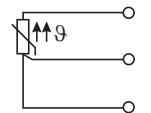
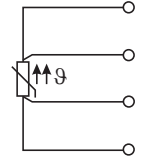
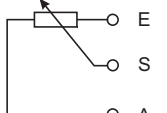
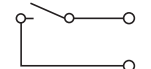
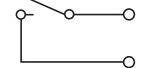

5.3.3 Main input board (area II)

Function	Symbol	Terminal
Standard signal input for electrical current 0(4) to 20 mA		3 4
Standard signal input for voltage 0(2) to 10 V or 10 to 0(2) V		1 2
Temperature sensor in a two-wire circuit Pt100 or Pt1000		2 3 4
Temperature sensor in a three-wire circuit Pt100 or Pt1000		2 3 4
Temperature sensor in a four-wire circuit Pt100 or Pt1000		1 2 3 4
Resistance transmitter		4 3 2
Binary inputs		
Binary input 1		6+ 10
Binary input 2		7+ 10

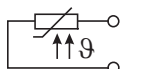
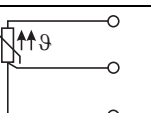
5.3.4 Optional boards (area III, slot a, b or c)

Function	Symbol	Terminal for slot (a)	Terminal for slot (b)	Terminal for slot (c)
Analog input				
Temperature sensor in a two-wire circuit Pt100 or Pt1000		2 4	6 8	10 12
Temperature sensor in a three-wire circuit Pt100 or Pt1000		2 3 4	6 7 8	10 11 12

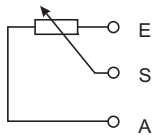
5 Installation of type 202553 (AS)

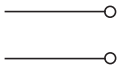
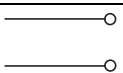
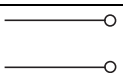
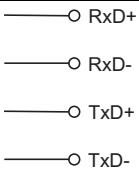
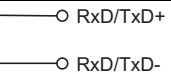
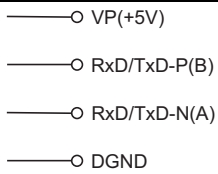
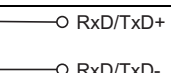
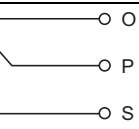
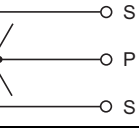
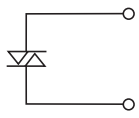
Function	Symbol	Terminal for slot (a)	Terminal for slot (b)	Terminal for slot (c)
Resistance transmitter		2 3 4	6 7 8	10 11 12
Electrical current		3 4	7 8	11 12
Voltage 0(2) to 10 V		1 2	5 6	9 10
Voltage 0 to 1 V		2 3	6 7	10 11
Continuous output				
Current or voltage		2 3	6 7	10 11
Modbus interface				
RS422				9 10 11 12
RS485				11 12
PROFIBUS-DP interface				
				9 10 11 12
Datalogger interface				
RS485				10 11
Relay (1x changeover)				
		K3 1 2 3	K4 5 6 7	K5 9 10 11
Relay (2x NO, common pin)				
		K3 1 2 K6 3		K5 9 10 K8 11
Triac (1 A)				
		K3 2 3	K4 6 7	K5 10 11
Function	Symbol	Terminal for slot (a)	Terminal for slot (b)	Terminal for slot (c)

5 Installation of type 202553 (AS)

PhotoMOS [®] relay (0.2 A)				
		K3 1	K4 5	K5 9
		2	6	10
		K6 3	K7 7	K8 11
		4	8	12
Voltage supply for ISFET sensor				
DC ±5 V		1	5	9
GND		2	6	10
		3	7	11
		4	8	12
DC +12 V		1	5	9
GND		2	6	10

6 Coaxial cable/setup interface

6.1 Coaxial cable

6.1.1 Coaxial cable with Shield-Kon[®] connector

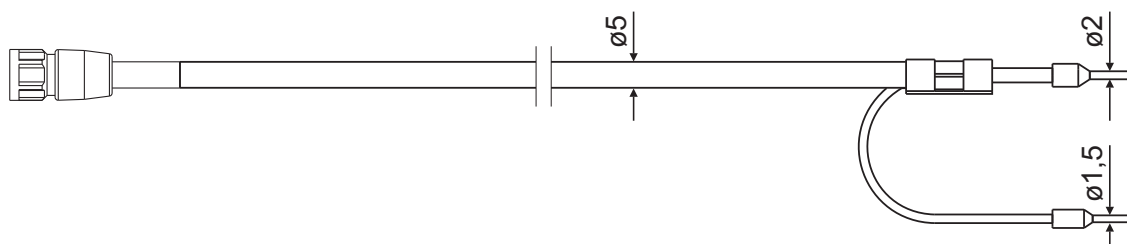

Type	Length	Part no.
202990/02-92-1.5-13	1.5 m	00085154
202990/02-92-5-13	5 m	00307298
202990/02-92-10-13	10 m	00082649

6.1.2 Preparing coaxial cable for your own requirements

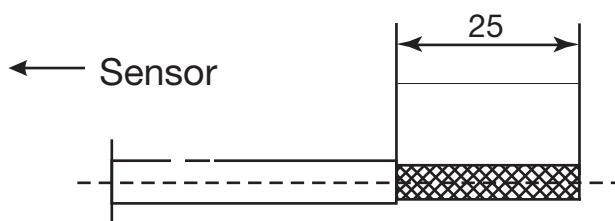

- * Remove the outer cable sheathing.
- * Strip back the braiding.

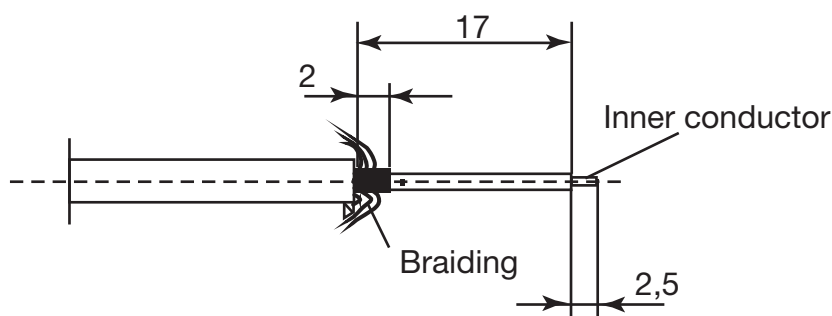

- * Remove the black semiconducting layer (see illustration).
- * Remove the inner insulation.



CAUTION!

The black semiconducting layer must not touch the inner conductor! If it does, the signal of the pH electrode will be short-circuited.

6 Coaxial cable/setup interface

6.2 Connecting the setup interface



NOTE!

The setup interface can only be operated with the upper enclosure cover open.

The following items are required:

PC interface cable with USB/TTL converter and two adapters (USB connecting cable), part no. 00456352.

- * Unscrew the upper cover (1), see section 2.1 "Opening the cover", page 7
- * Plug the connector for the setup interface into the instrument socket (2).

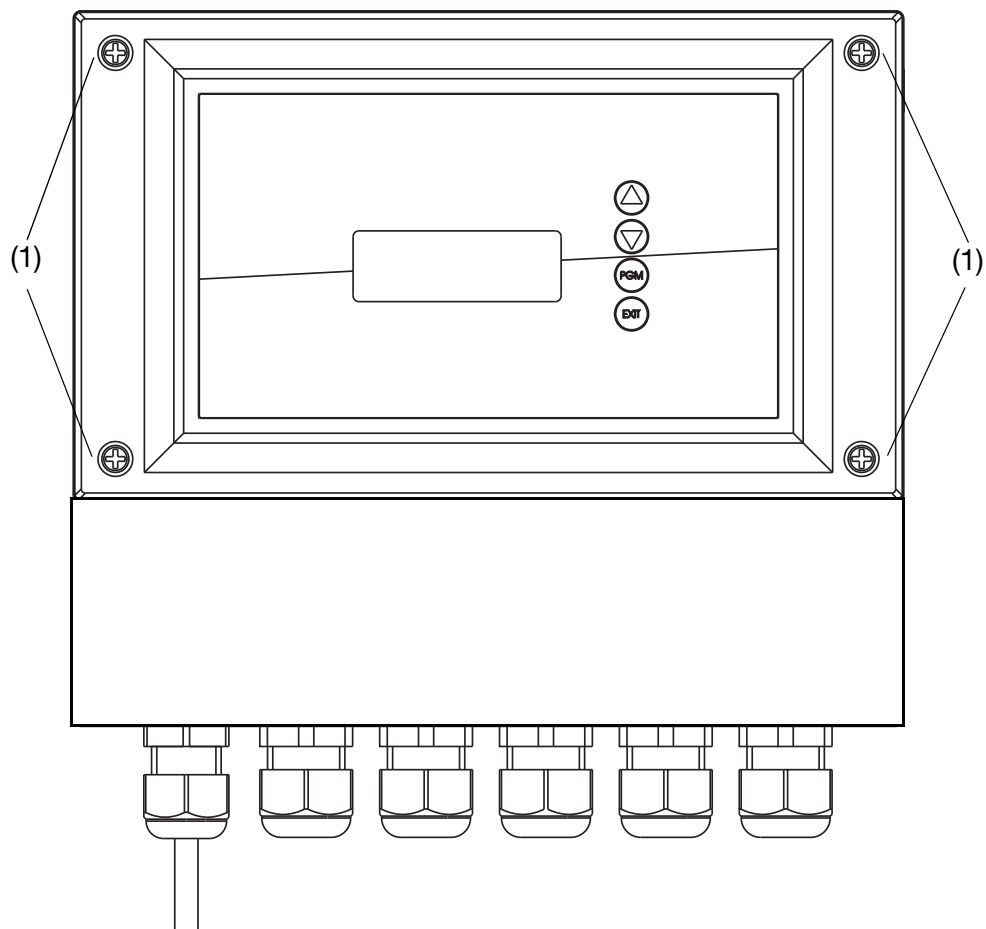

6 Coaxial cable/setup interface

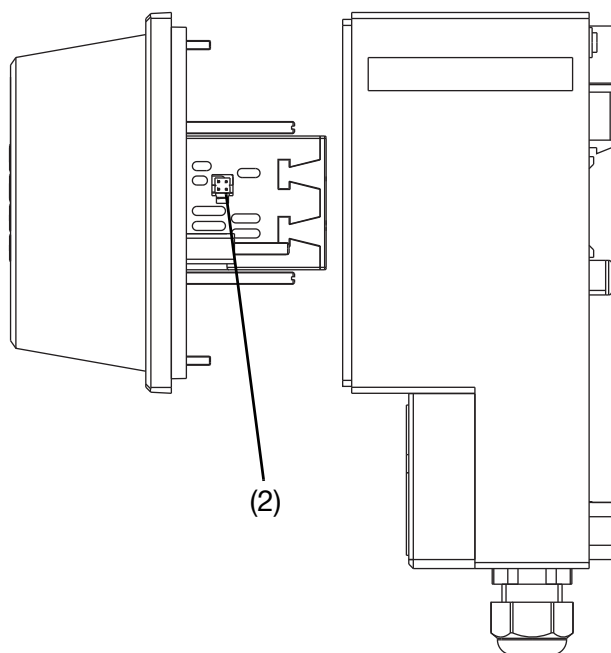

6 Coaxial cable/setup interface

6.2.1 Mounting the upper cover



CAUTION!

Check if seal is intact.

Screw torque on the upper cover (1): ≤ 2 Nm.

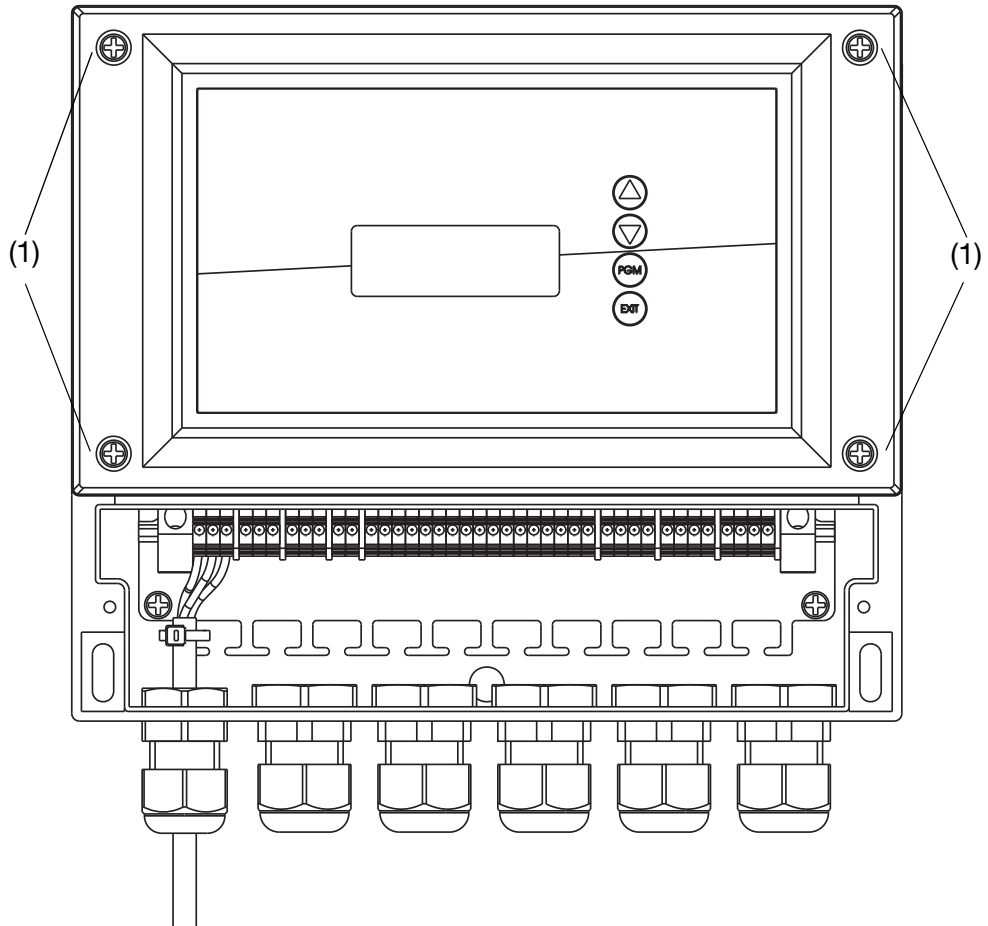



JUMO GmbH & Co. KG

Street address:
Moritz-Juchheim-Straße 1
36039 Fulda, Germany
Delivery address:
Mackenrodtstraße 14
36039 Fulda, Germany
Postal address:
36035 Fulda, Germany
Phone: +49 661 6003-0
Fax: +49 661 6003-607
E-mail: mail@jumo.net
Internet: www.jumo.net

JUMO Instrument Co. Ltd.

JUMO House
Temple Bank, Riverway
Harlow - Essex CM20 2DY, UK
Phone: +44 1279 63 55 33
Fax: +44 1279 63 52 62
E-mail: sales@jumo.co.uk
Internet: www.jumo.co.uk

JUMO Process Control, Inc.

6733 Myers Road
East Syracuse, NY 13057, USA
Phone: 315-437-5866
1-800-554-5866
Fax: 315-437-5860
E-mail: info.us@jumo.net
Internet: www.jumousa.com